

- Set up reflector according to technical specification
- Einstellen des reflektors gemäß der lichttechnische berechnung
- Instellen van reflector volgens technische specificaties
- Ensemble de reflecteurs selon spécifications techniques
- Colocación del reflector de acuerdo con las especificaciones
- Installazione del riflettore in accordo con le specifiche tecniche
- Ustawienie odbłyśnika zgodnie ze specyfikacją projektową

SGS 103 42/60A
SGS 101/103 FG 42/60A

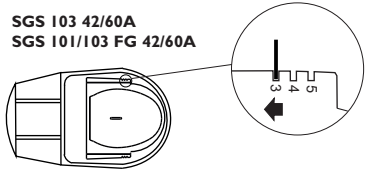

SGS 104 42/60A
SGS 102/104 FG 42/60A

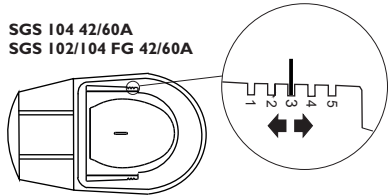

SGS 101 42/60
SGS 101 FG
SGS 101 42/60A

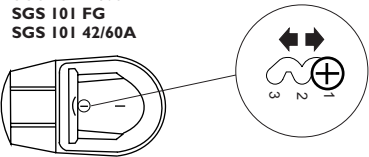

SGS 102 42/60
SGS 102 FG
SGS 102 42/60A

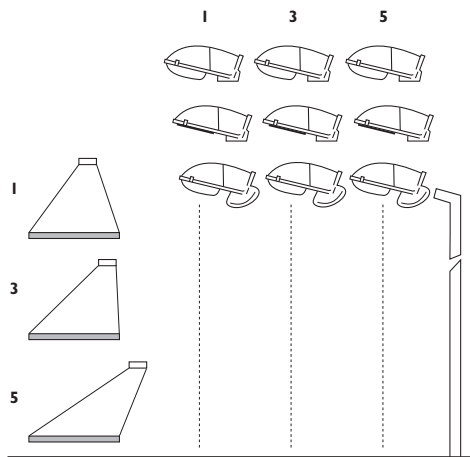
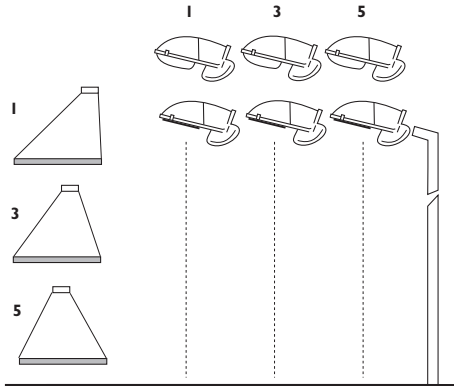
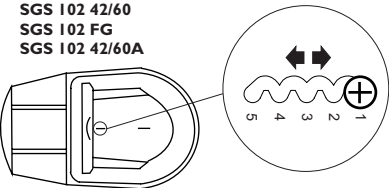

12

SGS WITH POWER SWITCH

General informations about controllers, see **POWER SWITCH PROGRAMMING INSTRUCTION**

13

Philips Malaga SGS101/102 / Malaga 2 SGS103/104

Mounting instructions

Instructions de montage Istruzioni di montaggio Szereelési útmutató
Installation instructions Instrucciones de montaje Instrukcja montażu
Montageanweisung Montážní návod
Montagevoorschrift Montážny návod

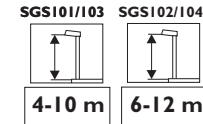
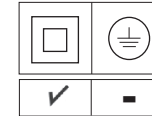

Malaga / Malaga 2

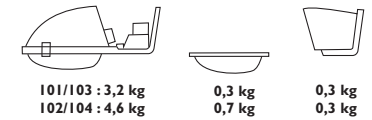
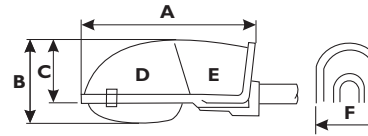

101/103 : 3,2 kg
102/104 : 4,6 kg

0,3 kg
0,7 kg

0,3 kg
0,3 kg

	A	B	C	D	E	F	SCx max	IK
SGS101/103	510	170	160	IP65	IP43	300	0,04m ²	IK08
SGS102/104	635	205	195			375	0,06m ²	

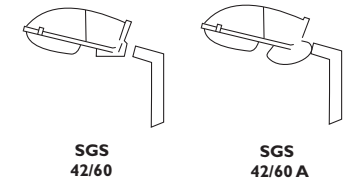

SGS
42/60

SGS
42/60 A

Malaga / Malaga 2 FG

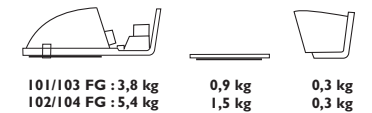
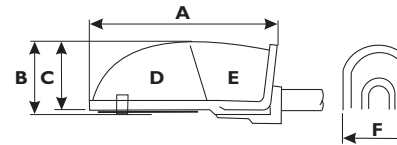

101/103 FG : 3,8 kg
102/104 FG : 5,4 kg

0,9 kg
1,5 kg

0,3 kg
0,3 kg

	A	B	C	D	E	F	SCx max	IK
SGS101/103 FG	510	170	160	IP65	IP43	300	0,04m ²	IK08
SGS102/104 FG	635	205	195			375	0,06m ²	

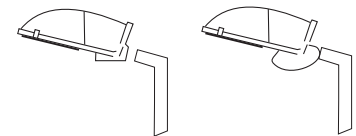

SGS FG
42/60

SGS FG
42/60 A

1

12NC 4427 100 66620 SGS
Version date: 08/11
Data subject to change without notice
Printed in Poland
www.philips.com/lighting

PHILIPS

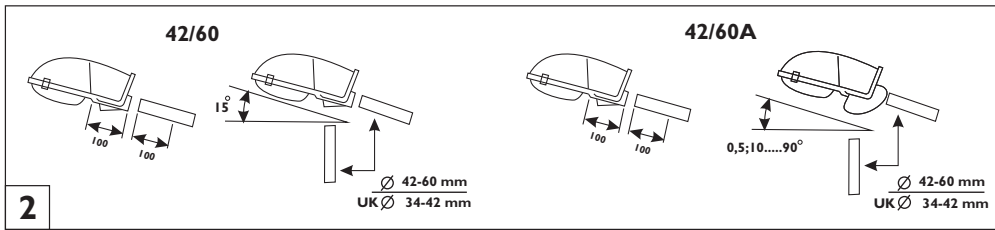

3

Malaga SGS				Malaga 2 SGS			
I01	I01 FG	I02	I02 FG	I03	I03 FG	I04	I04 FG
SON-T 50-70W		SON-T 100-250W		SON-T 50-70W		SON-T 100-250W	
SON-I 70W	-	-	-	-	-	-	-
-	-	CDO-TT 150W	-	-	-	-	-
HPL-N 80-125W	-	HPL-N 250W	-	-	-	HPL-N 250W	-

